



2-Wire Gas Detector Head

GD-K88Ai

Operating Manual

(PT2-193)

Part Number: 71-0415

Revision: P1

Released: 1/25/17

RIKEN KEIKI Co., Ltd.

2-7-6 Azusawa, Itabashi-ku, Tokyo, 174-8744, Japan

Phone : +81-3-3966-1113

Fax : +81-3-3558-9110

E-mail : intdept@rikenkeiki.co.jp

Web site : <http://www.rikenkeiki.co.jp/english/>

<Contents>

1. Outline of the Product.....	3
1-1. Preface.....	3
1-2. Purpose of use.....	3
1-3. Definition of DANGER, WARNING, CAUTION, and NOTE.....	4
2. Important Notices on Safety.....	5
2-1. Danger cases.....	5
2-2. Warning cases.....	6
2-3. Precautions.....	7
2-4. Operating precautions.....	7
2-5. Important information about explosion-proof.....	8
3. Product Components.....	10
3-1. Main unit and standard accessories.....	10
3-2. Names and functions for each part.....	11
4. How to Use.....	12
4-1. Before using the detector.....	12
4-2. Precautions for installation sites.....	13
4-3. Precautions for system designing.....	14
4-4. How to install.....	15
4-5. Grounding.....	16
4-6. How to wire.....	17
4-7. Compatible cables and terminal plate specifications.....	17
4-8. System connection example.....	18
5. How to Operate.....	20
5-1. Preparation for start-up.....	20
5-2. Basic operating procedures.....	20
5-3. How to start the detector (power-on).....	21
5-4. Modes.....	22
5-5. Description of operation (detection mode).....	23
5-6. Description of operation (maintenance).....	26
5-7. How to exit.....	29
6. Maintenance.....	30
6-1. Maintenance intervals and items.....	30
6-2. Replacement parts.....	32
7. Storage, Relocation and Disposal.....	33
7-1. Procedures to store the detector or leave it for a long time.....	33
7-2. Procedures to relocate the detector or use it again.....	33
7-3. Disposal of products.....	33
8. Troubleshooting.....	34
9. Product Specifications.....	36
9-1. List of specifications.....	36
9-2. Detection principle.....	37
10. Definition of Terms.....	38

1

Outline of the Product

1-1. Preface

Thank you for choosing our 2-wire gas detector head GD-K88Ai.
Please check that the model number of the product you purchased is included in the specifications on this manual.



This manual explains how to use the detector and its specifications. It contains information required for using the detector properly. Not only the first-time users but also the users who have already used the product must read and understand the operating manual to enhance the knowledge and experience before using the detector.

When the detector is used in combination with an indicator/alarm unit, read also the operating manual of the indicator/alarm unit.

1-2. Purpose of use

- This detector is a fixed type gas detector head which detects combustible and toxic gases.
- When the detector detects gas leakage, it outputs a current according to the gas concentration. The indicator/alarm unit indicates the gas concentration and triggers an alarm if a preset concentration level is exceeded.
- The detector is a safety unit, not an analyzer or densitometer which performs quantitative/qualitative analysis/measurement for gases. Please fully understand the features of the detector before using it, so that it can be used properly.

1-3. Definition of DANGER, WARNING, CAUTION, and NOTE

 DANGER	This message indicates that improper handling may cause serious damage on life, health or assets.
 WARNING	This message indicates that improper handling may cause serious damage on health or assets.
 CAUTION	This message indicates that improper handling may cause minor damage on health or assets.
NOTE	This message indicates advice on handling.

2

Important Notices on Safety

2-1. Danger cases



DANGER

This detector is the intrinsically safe explosion-proof product with Zener Barrier. However, never attempt to detect a gas over the lower explosive limit.

2-2. Warning cases



WARNING

- **Power supply**
Before turning on the detector, always check that the voltage is properly applied.
- **Need of grounding circuit**
Do not cut the grounding circuit inside or outside the detector or disconnect the wire from the grounding terminal.
In both of the cases, the detector will be in danger.
- **Defects in protective functions**
When seeming defects are found in the protective functions, such as protective grounding, do not start the detector.
Before starting the detector, check the protective functions for defects.
- **Grounding Zener Barrier**
Arrange A type grounding for Zener Barrier.
- **Operation in a gas**
The detector employs the intrinsically safe explosion-proof structure (Zener Barrier used separately).
It can be used in a location where a combustible gas, or steam is present; however, it should be done carefully.
Consult RIKEN KEIKI before operating the detector in such a location.
- **External connection**
Before connecting the detector to the external control circuit, securely connect it to a protective grounding circuit.
- **Handling of sensor**
Do not disassemble the sensor unit because it contains electrolyte. If contact occurs, rinse the area immediately with water.
- **Calibration**
When performing calibration for the detector, be careful not to lack calibration gases by loosing tubes.
- **Response to gas detection**
When a gas is detected, it indicates a potentially dangerous situation. Take proper actions based on your judgment.

2-3. Precautions



CAUTION

- Do not use a transceiver near the detector.
Radio wave from a transceiver or other radio wave transmitting device near the detector or its cables may disturb readings.
If a transceiver or other radio wave transmitting device is used, it must be used in a place where it disturbs nothing.
- To restart the detector, wait for five seconds or longer before switching on detector.
Restarting the detector within five seconds may cause errors.
- Careful consideration should be given to instrumentation to maintain safety even when a trouble like disconnection of power/signal cable or unexpected malfunction or failure occurs.
- This is an electrical appliance. Be careful that it may be affected, in rare cases, by power supply noises, static electricity and electromagnetic noises. Before using the detector in an environment with such noises, provide for protective measures against them.

2-4. Operating precautions

This detector is a gas detector that detects combustible and toxic gases in the air and outputs gas concentration signals.

The gas detector is a safety unit, not an analyzer or densitometer which performs quantitative/qualitative analysis/measurement for gases.

Please fully understand the following points before using it, so that it can be used properly.

1. The detector may be interfered by gases other than the gas to be detected, solvents, vapors etc.
Please note that the gas concentration signal may be fluctuated by interference. In addition, it may be fluctuated by environmental (temperature, humidity, etc.) changes in the installation site.
2. The alarm must be set within a range where the performance of the detector can be ensured.
In facilities compliant with the High Pressure Gas Safety Act, an alarm setting below our standard alarm setpoint (threshold limit value) may trigger a false alarm.
3. This is a safety unit, not a control unit.
Use the analog signal output of the detector for an indicator or external recorder.
If these outputs are used to control other units, we shall not be responsible for any malfunctions.
4. Because the contact point of the gas detector sensor is made of porous polymeric membrane, the water repellency of the membrane is deteriorated by solvents, thus causing an electrolyte leak from its inside. Do not use solvents near the detector.
If a solvent is used for unavoidable reasons, attach the recommended filter to the areas such as inlet of the gas detector while using the solvent and for one hour after that.
5. For maintenance of the detector, it must go through a regular maintenance, including replacement and adjustment of the regular replacement parts as specified in the operating manual. In addition, because this is a safety unit, it is recommended that a regular maintenance and a calibration are performed every six months in accordance with the regulations.

2-5. Important information about explosion-proof

The detector is an explosion-proof product.

The following provides information about the explosion-proof structure. Understand the information in this section thoroughly before using the detector.

- Explosion-proof structure and class

The detector employs the following explosion-proof structure and class. Use the detector according to the operating environment.

Explosion-proof structure	:	Intrinsically safe explosion-proof structure
Explosion-proof class	:	ExialICT4X
Certificate number	:	
Certification body	:	Technology Institution of Industrial Safety
Applied standard	:	Recommended Practices for Explosion-Protected Electrical Installations in General Industries

Electrical parameter

Intrinsically safe circuit allowable voltage (U_i)	:	28 V
Intrinsically safe circuit allowable current (I_i)	:	93 mA
Intrinsically safe circuit allowable power (P_i)	:	0.65 W
Internal capacitance (C_i)	:	586 pF
Internal inductance (L_i)	:	Negligible value

Operating temperatures : -20 - +50°C (*1)

Protective class of case : IP20 (Water-proof: None/Dust-proof: Up to 12.5 mm foreign solid material protected)

Insulation performance : Meet JIS standard (between the power supply and case, 500 VAC, one minute) under the condition that the capacitor connected to the terminal plate has been removed.

- System configuration

Make up the system as shown below.

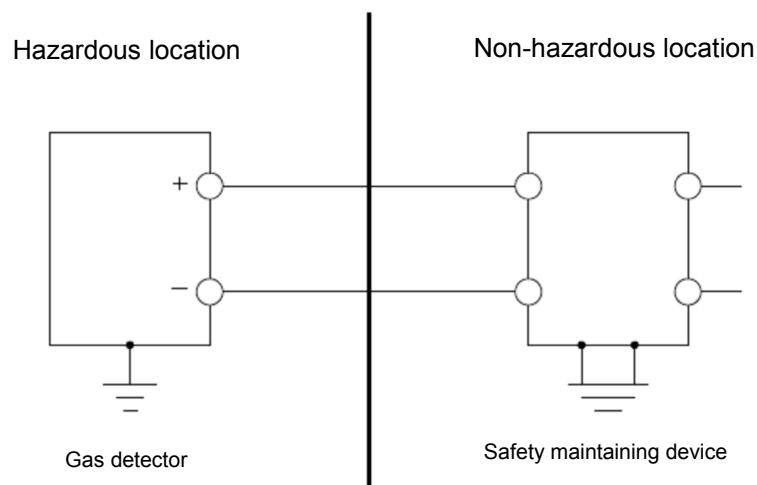

Important information about explosion-proof (continued)

- **Power supply**
Never fail to use the following safety maintaining device (barrier) to maintain explosion-proof performance.

Ratings to maintain safety

Intrinsically safe circuit maximum voltage (U_0)	:	28 V
Intrinsically safe circuit maximum current (I_0)	:	93 mA
Intrinsically safe circuit maximum power (P_0)	:	0.65 W

Performance classification and group

Performance classification	:	ia
Group	:	IIC

Relations between the intrinsically safe circuit allowable inductance (L_0) and intrinsically safe circuit external wire inductance (L_w) and between the intrinsically safe circuit allowable capacitance (C_0) and intrinsically safe circuit external wire capacitance (C_w)

Intrinsically safe circuit allowable inductance (L_0)	=	L_w or more
Intrinsically safe circuit allowable capacitance (C_0)	=	$586 \text{ pF} + C_w$ or more
 - **Wiring**
Determine the cable type to use and laying distance in consideration of the above parameters to maintain explosion-proof performance.
Perform wiring so that a current or voltage that disturbs intrinsically safe explosion-proof performance of the intrinsically safe circuit is not induced to the circuit due to electromagnetic or electrostatic induction.
 - **Battery**
The detector contains a battery for sensor backup. Observe the followings to maintain explosion-proof performance.
<Usable battery>
Only the following battery can be used. Contact RIKEN KEIKI if it is difficult to purchase the battery.

Type	:	AAA alkaline dry battery
Model	:	LR03
Nominal voltage	:	1.5 V
Manufacturer	:	TOSHIBA Corporation

 <Battery Replacement>
Turn off the power of the detector before replacing the battery.
Never fail to use the dedicated battery storage case.
 - **Grounding**
Never fail to ground the detector (D type grounding).
 - **Others**
Confirm that no combustible gas is present around before opening the door of the unit.
Never disassemble or modify the unit.

Manufacturer: RIKEN KEIKI Co., Ltd.
 2-7-6 Azusawa, Itabashi-ku, Tokyo, 174-8744 Japan
 www.rikenkeiki.co.jp
- *1: The temperature range to maintain explosion-proof performance
The temperature range to maintain gas detection performance is 0 to 40°C. (See Specifications)

3

Product Components

3-1. Main unit and standard accessories

<Main Unit>

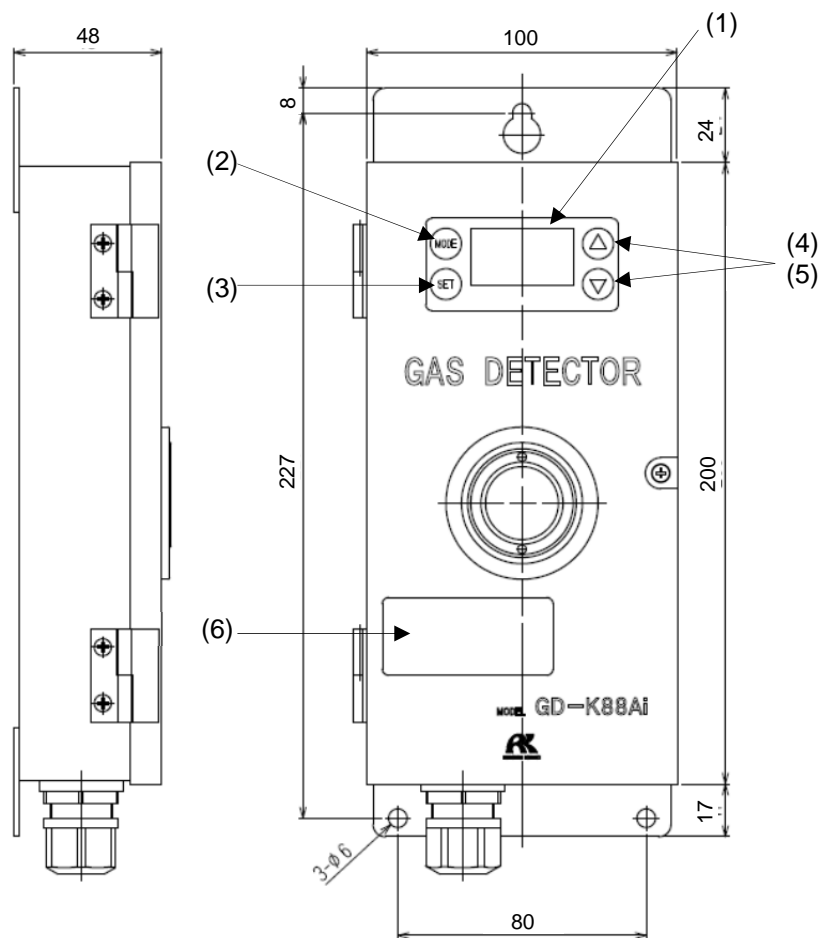

- | | | |
|--------|----------------|--|
| (1) | LCD display | Display the gas concentration. (Used at maintenance) |
| (2) | MODE switch | Switches the mode from the detection mode to maintenance mode. Or exits the maintenance mode. |
| (3) | SET switch | Used to set the mode during the maintenance mode. |
| (4)(5) | UP/DOWN switch | Used to select an item for each maintenance mode, increase/decrease a reading in zero adjustment or external output test, etc. |
| (6) | Nameplate | Shows ratings, etc. |

<Standard Accessories>

- CF-82 CO sensor filter: Attached when the gas to be detected is CO (carbon monoxide).

3-2. Names and functions for each part

<Front View of Detector Unit>

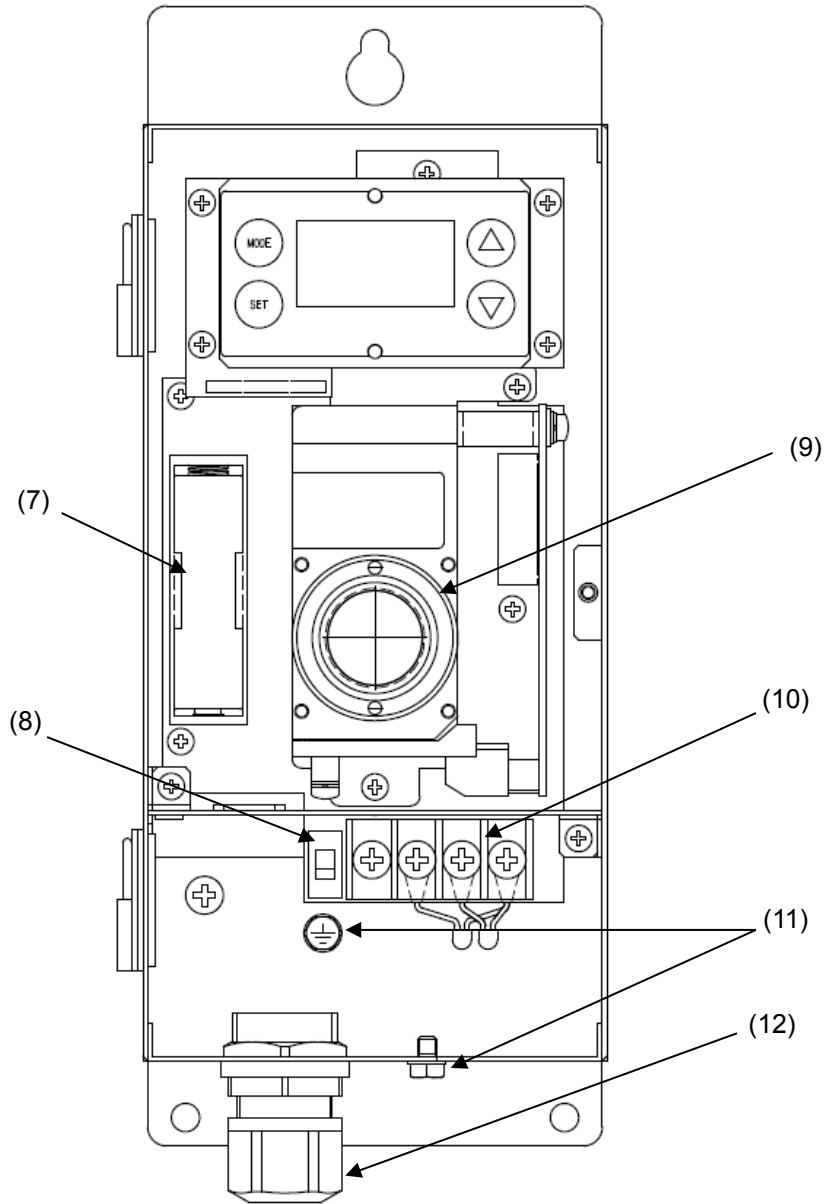

- | | | |
|------|--------------------|---------------------------------------|
| (7) | Battery box | Houses the battery for sensor backup. |
| (8) | Power switch | Turns ON/OFF the power of the unit. |
| (9) | Sensor | Detects a gas. |
| (10) | Terminal plate | Connects the power cable. |
| (11) | Grounding terminal | A terminal (M4) to ground the unit. |
| (12) | Cable inlet | An inlet for connected cable. |

4

How to Use

4-1. Before using the detector

Not only the first-time users but also the users who have already used the alarm system must follow the operating precautions.

Ignoring the precautions may damage the alarm system, resulting in inaccurate gas detection.

4-2. Precautions for installation sites



CAUTION

- This is a precision device. Because the detector may not provide the specified performance in some places (environments), check the environment in the installation point, and then take appropriate actions if necessary.
- Because the detector plays an important role for safety and disaster prevention, as many units of the detector as needed must be installed in appropriate points.
Because points where gases leak and gathering are different depending on the types of gases and the working areas, please decide carefully on installation points and the number of units to be installed.

Do not install the detector in a place with vibrations or shocks.

The detector consists of sensitive electronic parts. The detector must be installed in a stable place without vibrations or shocks and it cannot drop.

Do not install the detector in a place exposed to direct sunlight or sudden changes in the temperature.

When selecting installation points, avoid a place where it is exposed to direct sunlight or radiant heat (infrared rays emitted from a high-temperature object), and where the temperature changes suddenly. Condensation may be formed inside the detector, or the detector cannot adjust to sudden changes in the temperature.

Keep the detector (and its cables) away from noise source devices.

When selecting installation points, avoid a place where high-frequency/high-voltage devices exist.

- Do not place the detector next to a noise source device.
- Do not run cables in parallel or close to each other.

Do not install the detector in a place where maintenance of the detector cannot be performed or where handling the detector involves dangers.

Regular maintenance of the detector must be performed.

Do not install the detector in a place where the machinery must be stopped when maintenance is performed in its inside, where parts of the machinery must be removed to perform maintenance, or where the detector cannot be removed because tubes or racks, etc. prevent access to it.

Do not install the detector in a place where maintenance involves dangers, for example, near a high-voltage cable.

Do not install the detector in machinery which is not properly grounded.

Before installing the detector in machinery, the machinery must be grounded properly.

Do not install the detector in a place where interference gases exist around it.

The detector must not be installed in a place where interference gases exist around it.

4-3. Precautions for system designing



CAUTION

An unstable power supply and noise may cause malfunctions or false alarms. The descriptions in this section must be reflected on the designing of a system using the detector.

Using a stable power supply

The external output and alarm contact of the detector may be activated when the power is turned on, when momentary blackout occurs, or while the system is being stabilized. In such cases, use a UPS (uninterruptible power system), or take appropriate actions on the receiving side.

The detector must be provided with the following power supply.

Power supply voltage	15 - 27 VDC (terminal voltage of the main unit)	
Allowed time of momentary blackout	Approx. 1 msec. (To recover from the momentary blackout for 1 msec. or more, restart the detector.)	<u>Example of actions</u> To ensure continuous operation and activation, install a UPS, etc. outside the detector.
Others	Do not use it with a power supply of large power load or high-frequency noise.	<u>Example of actions</u> Use a line filter, etc. to avoid the noise source if necessary.

Heat radiation designing

When the alarm system is installed in a closed instrumentation panel or the like, attach ventilation fans above and below the panel.

Introducing protective measures against lightning

If cables are installed outside the factory/plant, or if internal cables are installed in the same duct as the cables coming from outside the factory/plant, "lightning" will cause problems. Because lightning acts as a large emission source while cables act as a receiving antenna, devices connected to the cables may be damaged.

Lightning cannot be prevented. Cables installed in a metal conduit or under the ground cannot be completely protected from inductive lightning surge caused by lightning. Although complete elimination of disasters caused by lightning is impossible, the following protective measures can be taken.

Protection against lightning	<p><u>Take appropriate measures in accordance with the importance of the facilities and the environment.</u></p> <ul style="list-style-type: none"> • Provide protection by a lightning arrester (cable arrester). (Although inductive lightning surge can be transmitted through the cable, it is prevented by installing a lightning arrester before the field devices and central processing equipment. For information on how to use a lightning arrester, please contact the manufacturer.)
Grounding	In addition to lightning, there are more sources of surge noise. To protect units from these noise sources, the units must be grounded.

* The lightning arrester has a circuit to remove a surge voltage which damages field devices, so that signals may be attenuated. Before installing a lightning arrester, verify that it works properly.

4-4. How to install

A certain maintenance space needs to be secured in advance to allow the maintenance personnel to safely and properly perform maintenance of the gas detector function and performance. Be sure to secure this space during construction planning or installation.

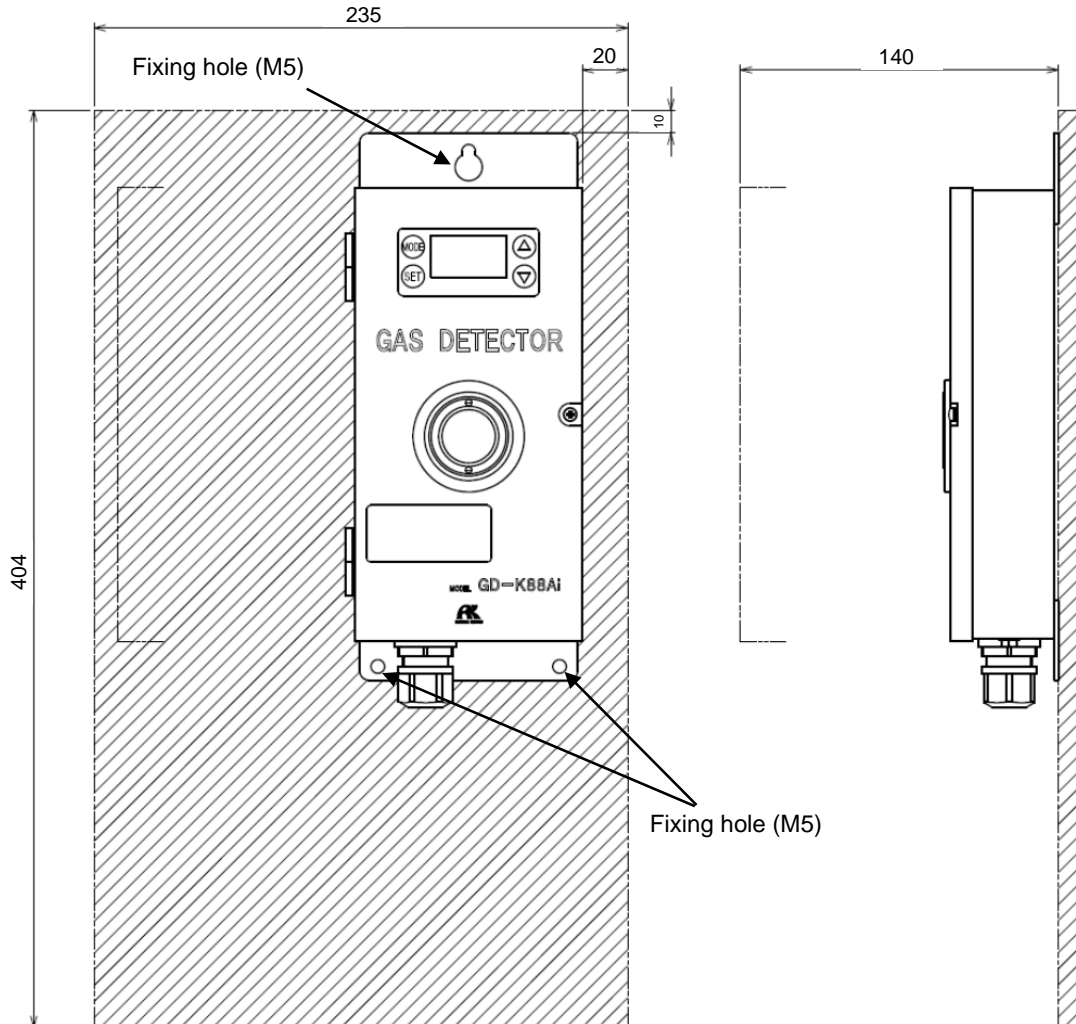

- (1) Mount the main unit on the wall.
- (2) Insert screws to the upper and lower fixing holes of the main unit and tighten them. (Use M5 screws.)



CAUTION

Check that the main unit is mounted securely on the wall. If not, the main unit may fall off and cause unexpected injury or damage to the unit.

Do not install the detector in a place where maintenance of the detector cannot be performed or where handling the detector involves dangers.

Regular maintenance of the detector must be performed.

Do not install the detector in a place where the machinery must be stopped when maintenance is performed in its inside, where parts of the machinery must be removed to perform maintenance, or where the detector cannot be removed because tubes or racks prevent access to it.

Do not install the detector in a place where maintenance involves dangers, for example, near a high-voltage cable.

4-5. Grounding

Connect the detector to your grounding terminal with the internal or external terminal.



WARNING

Before turning on the detector, never fail to connect it to a grounding terminal.

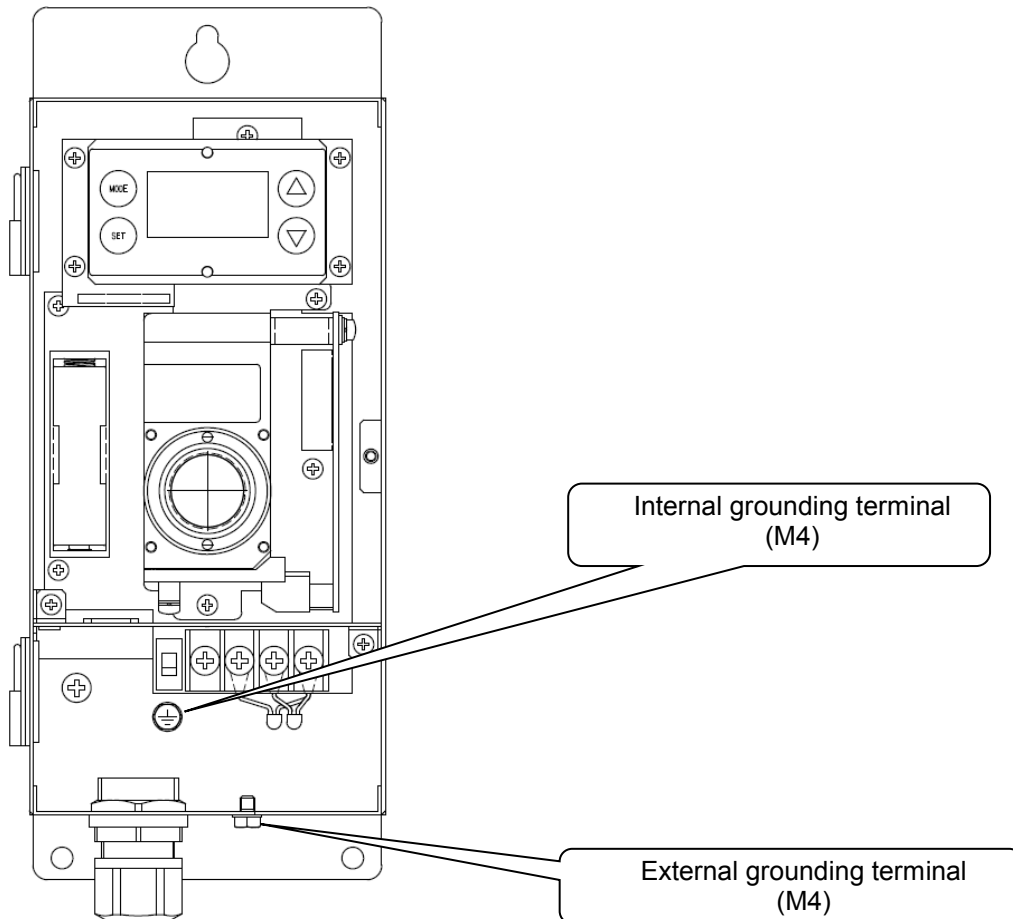

For stable operation of the detector and safety, it must be connected to a grounding terminal. Do not connect the grounding wire to a gas pipe. The grounding must be made as D type grounding (below 100 Ω of grounding resistance).



WARNING

Perform A type grounding when Zener Barrier is connected for explosion-proof specification.

4-6. How to wire



CAUTION

- Be careful not to damage the internal electronic circuit when wiring.
- The connected cables must not be installed together with the motor power cables, etc.
- When stranded wires are used, prevent wires from contacting each other.

4-7. Compatible cables and terminal plate specifications

<Recommended Cables>

Use CVVS 1.25 sq 2-core single or stranded wire.

<Specifications of Terminal Plate>

- Rated voltage: 250 VAC
- Rated current: 20 A

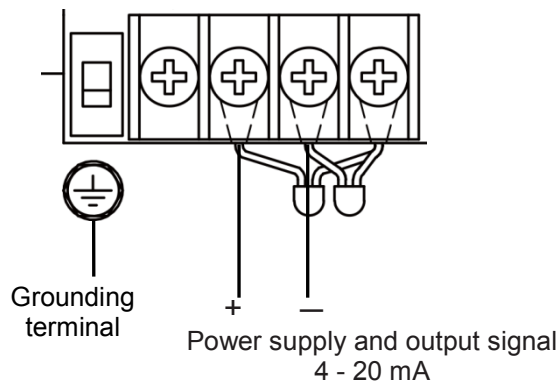

<Supply Voltage>

The supply voltage is normally 24 VDC.

However, the voltage at the terminal plate of the detector becomes lower than the source voltage, depending on the connected safety maintaining device (barrier), type and length of the cable used. It may also vary with the signal current value (4 to 20 mA).

When wiring the detector, check the following to make sure that the voltage at the terminal plate is appropriate.

The detector provides stable operation within the power voltage range of 15 to 27 VDC.

4-8. System connection example

4-8-1. Example of connecting to indicator, DCS, PLC, etc. (non-explosion-proof system)

Host system (DCS, PLC)

Non-hazardous location



4-8-2. Example of connecting to Zener Barrier, indicator, DCS, PLC, etc.

Non-hazardous location

Hazardous location

Upper unit (DCS, PLC)

Zener Barrier

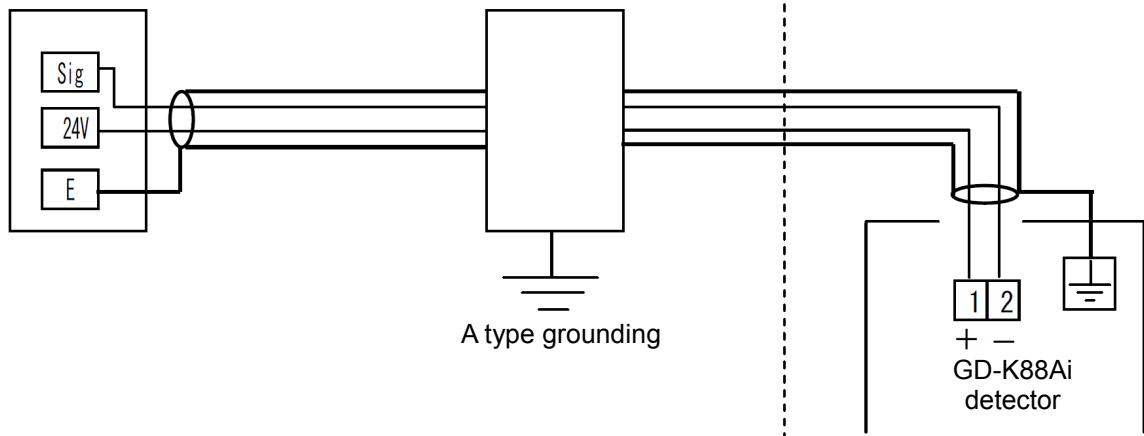

4-8-3. Example of connecting to Zener Barrier and indicator

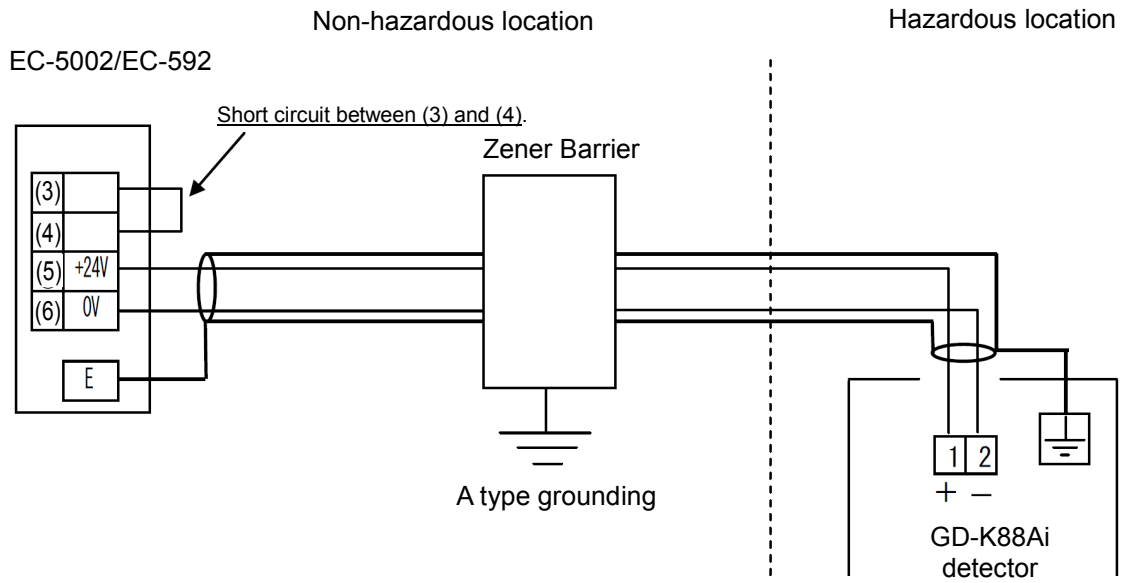

4-8-4. Example of connecting to insulating barrier, indicator, DCS, PLC, etc.

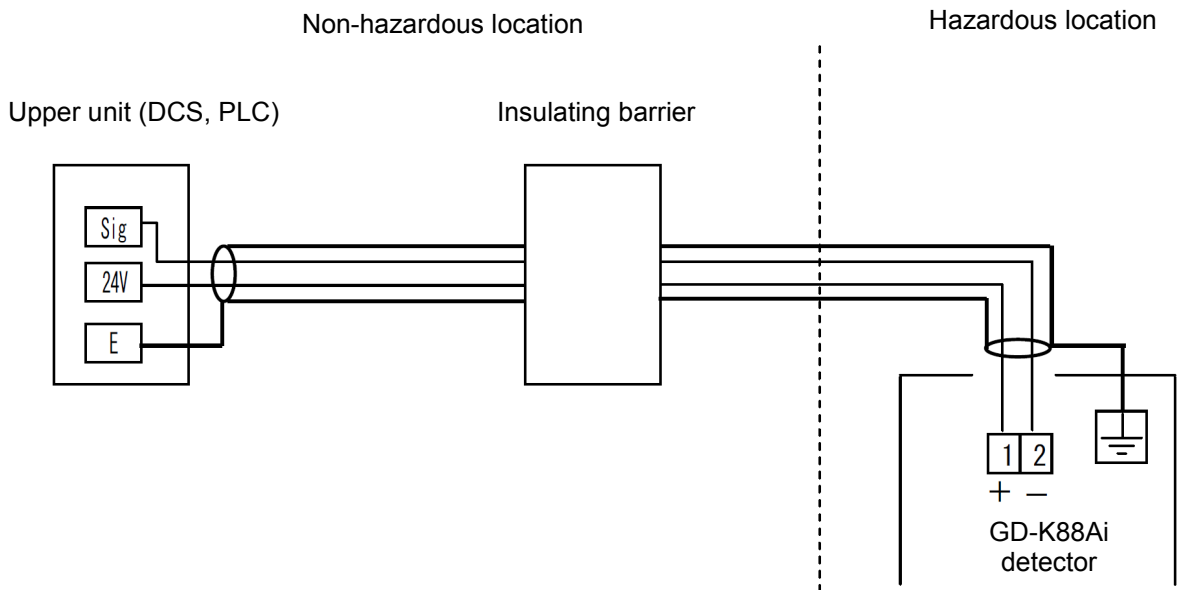

5

How to Operate

5-1. Preparation for start-up

Before connecting a power supply, read and understand the following precautions. Ignoring these precautions may cause an electric shock or damage the detector.

- Check that the detector is installed properly.
- Check that the detector is grounded.
- Check that the external wiring is done properly.
- Check that the power supply voltage meets the specifications.
- The external output may be fluctuated during adjustment. Take an appropriate measure to avoid the influence on the gas monitoring system.
- Make sure to use a fuse with the specified ratings to prevent fire.

5-2. Basic operating procedures

Normally, the detection mode is activated after the power is turned on.

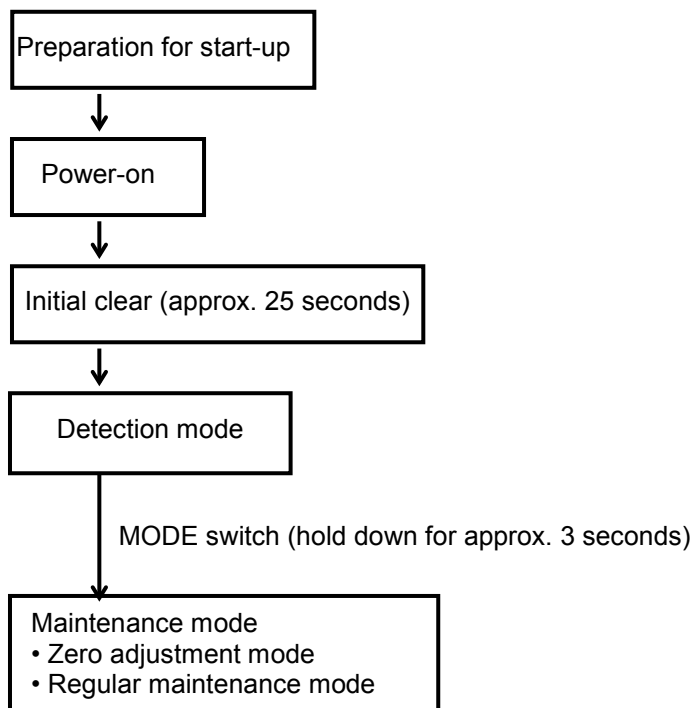

**CAUTION**

The regular maintenance mode is used by a qualified service engineer.

5-3. How to start the detector (power-on)

- Before supplying power to the detector, check that the preparation for start-up is completed.
- Turn on the power switch located on the left side of the power terminal plate.

<Initial Clear (approx. 25 seconds)>
System check of the unit
External output: 4.0 mA

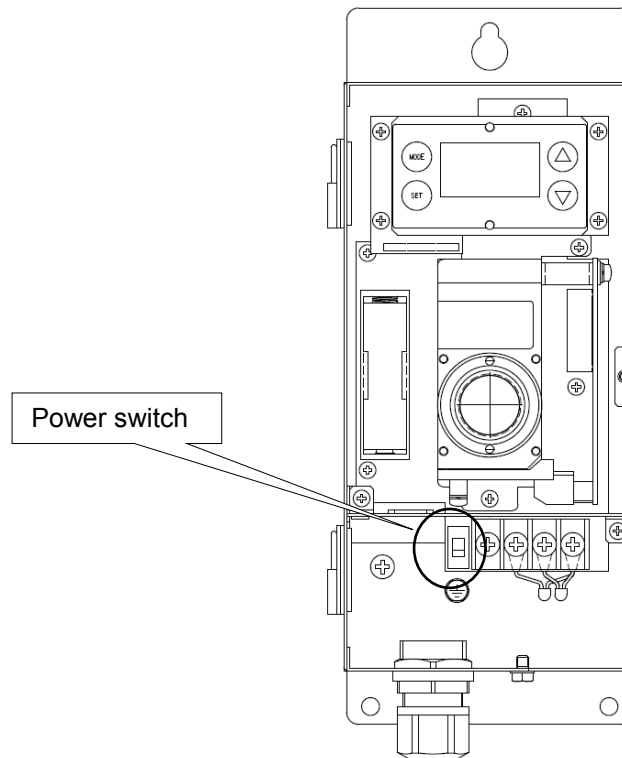
**CAUTION**

- Do not turn off the detector during the initial clear. The detector is reading the internal memory during the initial clear.
- If the detector is installed newly or the new sensor is replaced, the sensor must be warmed up for a specified period which is determined depending on the type of the sensor after the detector is started.
- After the warm-up is completed, perform a calibration.

5-4. Modes

Details on each mode are provided as follows.



CAUTION

- Do not change the settings if not necessary. Changing the settings without understanding the specifications may cause malfunctions.

Mode	Item	LED display	Details
Detection mode	-	Gas concentration	Normal state
Maintenance mode (User)	ROM/SUM display	1-0	Display the program version and others. This is not used by the user.
	Zero adjustment	1-1	Perform the zero adjustment.
	Setting display	1-2	Display various setting values.
	Regular maintenance mode switching	1-3	Switch to the regular maintenance mode.
Maintenance mode (Regular maintenance)	Test mode	2-0	Perform various tests. 2-0-0 Gas Test 2-0-1 Alarm Test 2-0-2 Fault Test 2-0-3 LCD Test 2-0-4 -----
	Zero adjustment	2-1	Perform the zero adjustment.
	Span adjustment	2-2	Perform the span adjustment.
	-----	2-3	-----
	Environmental setting	2-4	Used for various environmental settings. 2-4-0----- 2-4-1 INHIBIT Setting 2-4-2 Alarm Setpoint Setting 2-4-3 Alarm Delay Time Setting 2-4-4 Alarm Pattern Setting 2-4-5 Zero Suppression Type Setting 2-4-6 Zero Suppression Value Setting 2-4-7 ----- 2-4-8 ----- 2-4-9 Zero Follower Selection 2-4-A Maintenance Mode External Output Setting 2-4-B External Output Adjustment 2-4-C Alarm Test External Output Setting 2-4-D Sensor Operation Start Setting 2-4-E ----- 2-4-F ----- 2-4-G Alarm Limiter Setting 2-4-J Sensitivity Correction Setting 2-4-K Date/Time Setting 2-4-M ----- 2-4-N Fault External Output Setting
	Display	2-5	Display various electrical settings. This is not used by the user.
	Switch to factory mode	2-6	Not used.
	Switch to user mode	2-7	Return to the user mode.

5-5. Description of operation (detection mode)

5-5-1. Display operation

The operation status of the detector is displayed on the LCD.

Preparation



Power-on



Initial clear (approx. 25 seconds)



Detection mode

In the detection mode, the sampling gas concentration is displayed on the LCD.

LCD display (Example: Gas to be detected: CO)

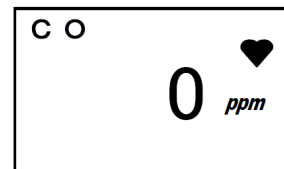
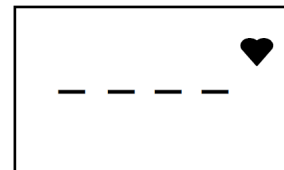

Normal display (description)

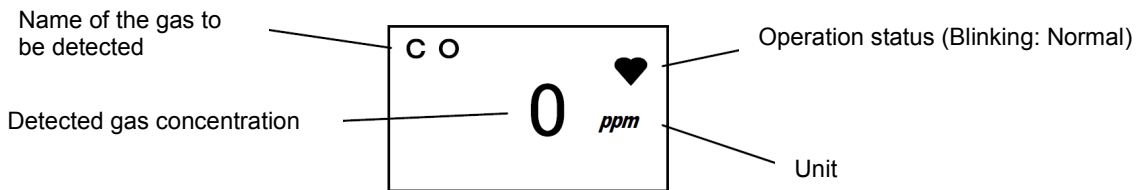

Gas alarm display

When a gas concentration exceeds the preset alarm setpoint, the gas alarm display appears and an alarm message (AL1 or AL2) is displayed in the lower left side on the display.

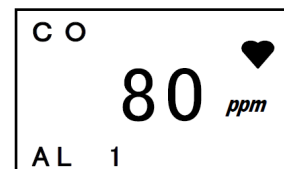

Negative value display

The "-0" display is shown when the zero level drops to the negative (-) side by 10% or more of the full scale.

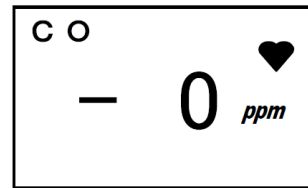

WARNING

Accurate gas detection cannot be performed with the negative value display. In this case, perform zero adjustment.

Fault Display

If a fault occurs on the detector, the fault detail is displayed on the LCD.

(LCD display)	(Fault detail)
E-9	System abnormalities
E-1	Sensor not connected/Sensor disconnection

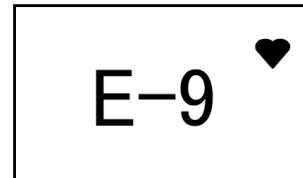

NOTE

See "8. Troubleshooting" for remedial actions to fault display.

5-5-2. External output operation

4 – 20 mA transmission

- (1) Signal transmission method : Electric current transmission (non-isolated)
- (2) Transmission path : CVVS 2c 1.25 sq
- (3) Transmission distance : 1000 m or less
- (4) Connection load resistance : 300 Ω or less
- (5) Status signal level
 - 1. Detection mode : 4.0 - 20.0 mA (depends on the gas concentration)
 - 2. Initial clear : 4.0 mA
 - 3. Maintenance mode : 4.0 mA or lower
 - 4. External output test : 4.0 - 20.0 mA (varies with the test value)
 - 5. Fault state : 3.5 mA
 - 6. Power off : 0.0 mA

The following figure shows the relation between "gas concentration" and "external output".

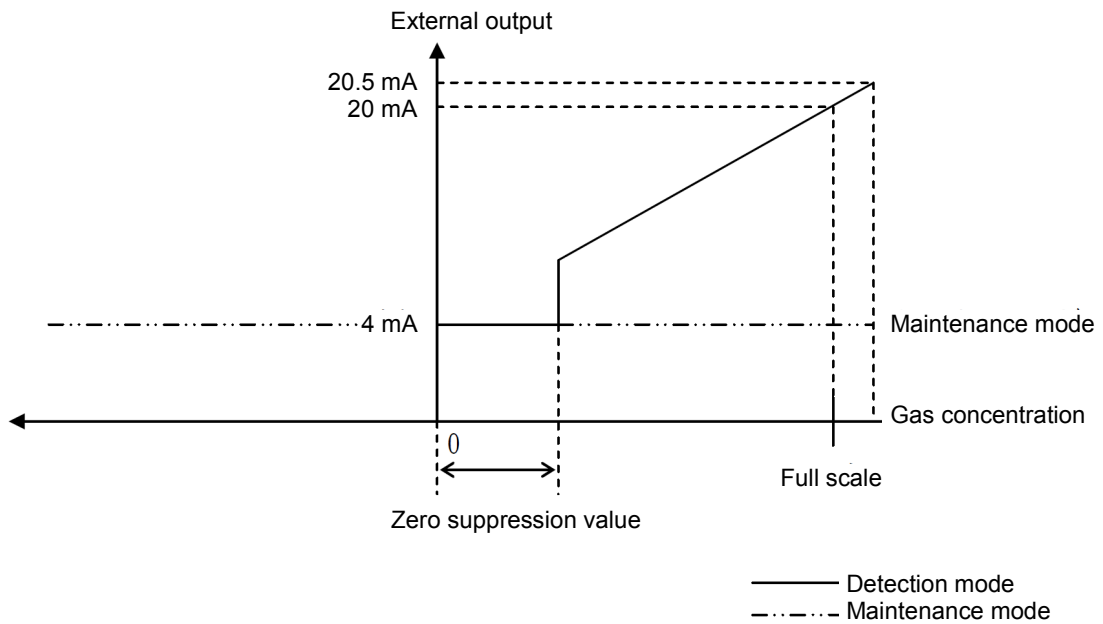

CAUTION

The 4 - 20 mA output is adjusted. If readjustment for 4-20mA is needed after installation, it must be done by a qualified service engineer.

5-6. Description of operation (maintenance)

5-6-1. Maintenance mode

Enter the maintenance mode to perform each adjustment.
 Holding down the MODE switch for three seconds in the detection mode enters the maintenance mode.
 Holding down the MODE switch for three seconds in the maintenance mode returns to the detection mode.
 If the maintenance mode is left unoperated for 10 hours, the detection mode automatically returns.

- 4.0 - 20.0 mA: 4.0 mA

Hold down the MODE switch for 3 seconds



Entering the maintenance mode

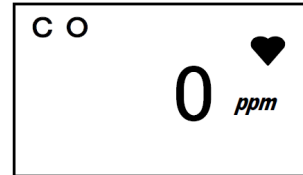

WARNING

When the maintenance mode is entered while gas detection is performed, the external output signal (gas concentration signal) becomes 4.0 mA (normal state).

- * The maintenance mode consists of "Daily Maintenance" and "Regular Maintenance", and "Daily Maintenance (Zero Adjustment)" is normally used.

"Daily Maintenance (Zero Adjustment)"

1-1. Zero Adjustment



Select with ▲/▼ switch

1-3. Regular maintenance mode

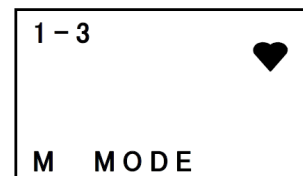

5-6-2. Zero adjustment

This is used to perform the zero adjustment.

NOTE

- If the zero calibration failed since the zero point was significantly fluctuated from zero, or by other reasons, it returns to 1-1 after FAIL is displayed. In this case, the zero adjustment has not been completed.

- (1) Hold down the MODE switch over three seconds to enter the maintenance mode.



- (2) Press the SET switch with the "1-1. Zero Adjustment" menu displayed. Introduce a zero adjustment gas. When the reading is stabilized, press the SET switch. The display blinks and zero adjustment is performed.



- (3) Press the SET switch to confirm the setpoint.



WARNING

Do not turn off the power until PASS disappears.



When the process ends normally, the LCD displays PASS and then goes to "1-1. Zero Adjustment" screen.



- (4) Hold down the MODE switch over three seconds to return to the detection mode.

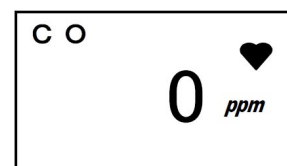

WARNING

After the adjustment is completed, never fail to press the MODE switch to return to the detection mode.



CAUTION

If the unit remains in the maintenance mode, it automatically returns to the detection mode in ten hours.

5-6-3. External output test

This is used to check the transmission status by outputting a signal equivalent to gas concentration to the external device.



WARNING

Before starting the external output test (transmission test), provide a notification to the related sections so that they can prepare for false alarm.

- (1) Hold down the MODE switch over three seconds to enter the maintenance mode.



- (2) Press the SET switch with the "1-3. Regular Maintenance Mode Switching" menu displayed.

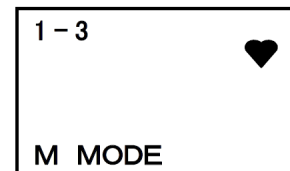

- (3) Holding down the SET switch while "----" is displayed enters the regular maintenance mode.

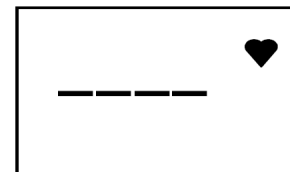

- (4) Press the SET switch while "2-0" is displayed to display "2-0-1. Alarm Test". Then make a selection with the SET switch.

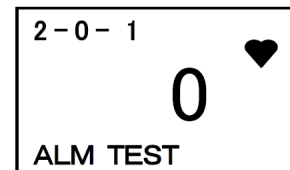

- (5) Increase the reading with the ▲/▼ switch to check the transmission status.
When the test is completed, hold down the MODE switch over three seconds to return to "2-0".

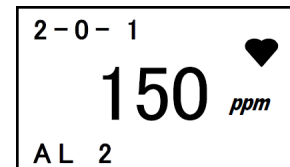

- (6) While "2-0" is displayed, hold down the MODE switch over three seconds to return to the detection mode.



5-7. How to exit

To turn off the detector, turn off the power switch located on the left side of the power terminal plate. Then, turn off the power supply (24 VDC) to the detector.



WARNING

Before turning off the detector, decide whether the power can be turned off by checking the operation of the devices connected to the external output of the detector.

6

Maintenance

The detector is an important instrument for safety.

To maintain the performance and reliability of the detector, perform a regular maintenance.

Continuing to use the detector without performing maintenance might cause the sensitivity degradation, thus resulting in inaccurate detection.

6-1. Maintenance intervals and items

- Daily maintenance : Perform maintenance before beginning to work.
- Monthly maintenance : Perform maintenance on the alarm circuit (alarm test) once a month.
- Regular maintenance : Perform maintenance once or more for every six months to maintain the performance as a safety unit.

Maintenance item	Maintenance content	Daily maintenance	Monthly maintenance	Regular maintenance
Status display check	Check that the status indicates normal measurement state.	○	○	○
Gas concentration display	Check that a gas to be detected is not present around the detector and that the reading indicates a normal value.	○	○	○
Alarm test*	Inspects the alarm circuit by using the alarm test function.	—	○	○
Span adjustment	Perform the span adjustment by using the calibration gas.	—	—	○
Gas alarm check	Check the gas alarm by using the calibration gas.	—	—	○

* Check and adjustment are performed at the indicator/alarm unit side. See the operating manual of the indicator/alarm unit for details.

<About Maintenance Services>

- We provide services on regular maintenance including span adjustment, other adjustments and maintenance.
To make the calibration gas, dedicated tools, such as a gas cylinder of the specified concentration and gas sampling bag must be used.
Our qualified service engineers have expertise and knowledge on the dedicated tools used for services, along with other products. To maintain the safety operation of the unit, please use our maintenance service.
- Typical maintenance services are listed as follows. Please contact RIKEN KEIKI for more information.

Main services

Power supply check	:	Checks the power supply voltage.
Status display check	:	Check that the status indicates normal measurement state.
Concentration display check*	:	Verifies that the concentration display value is zero by using the zero gas. Performs zero adjustment if the display is incorrect.
Alarm test*	:	Inspects the alarm circuit by using the alarm test function. <ul style="list-style-type: none"> • Checks the alarm lamps. (Checks the activation.) • Checks the external alarm. (Checks the activation of the external alarm, such as a buzzer.)
Span adjustment	:	Performs the span adjustment by using the calibration gas.
Gas alarm check*	:	Checks the gas alarm by using the calibration gas. <ul style="list-style-type: none"> • Checks the alarm. (Checks triggering of alarm when the alarm setpoint is reached.) • Checks the delay time. (Checks time to delay until the alarm is triggered.) • Checks the external alarm. (Checks the activation of external alarms, such as a buzzer and reset signal.)
Cleaning and repair of the unit (visual diagnosis)	:	Checks dust or damage on the surface, cover or internal parts of the unit, and cleans or repairs such parts as needed. Replaces parts which are cracked or damaged.
Unit operation check	:	Uses the keys to check the operation of functions, parameters, etc.
Replacement of consumable parts	:	Replaces consumable parts, such as a sensor and filter.

* Check and adjustment are performed at the indicator/alarm unit side.

6-2. Replacement parts

<Replacement of Gas Sensor>

Our service engineers need to replace and adjust the sensor. Please contact RIKEN KEIKI.

NOTE

- If adjustment to the standard gas concentration value fails even with the maximum sensitivity, it indicates that the gas sensor has come to the end of its life. The gas sensor needs to be replaced.
- After replacing the gas sensor, electrical adjustment and calibration using the standard gas are necessary.

<Replacement of Regular Replacement Parts>

List of recommended regular replacement parts

Part number	Name	Maintenance intervals	Replacement intervals	Quantity (pieces per unit)	Remarks
4253 9330 10	Battery Assy	————	————	1	*

- * Replaced together with the gas sensor. The operation must be checked after replacement by a qualified service engineer.
For the stable operation of the detector and safety, ask a qualified service engineer to take care of replacement of the parts. Request the operation check from RIKEN KEIKI.

NOTE

The above replacement interval is recommendation only. The interval may change depending on the conditions such as operating environment. These intervals do not mean the warranty periods either. The result of the regular maintenance may determine when to replace the parts.

7

Storage, Relocation and Disposal

7-1. Procedures to store the detector or leave it for a long time

The detector must be stored under the following environmental conditions.

- In a dark place under the normal temperature and humidity away from direct sunlight
- In a place where gases, solvents or vapors are not present

7-2. Procedures to relocate the detector or use it again

When the detector is relocated, select a new place in accordance with "4-2. Precautions for installation sites" and "4-4. How to install".

For information on wiring work, see "4-6. How to wire" and "4-7. Compatible cables and terminal plate specifications". The unpowered time must be minimized when the detector is relocated.



CAUTION

When using detector again after relocation or long-term storage, never fail to perform a calibration. For information on readjustment including a calibration, please contact RIKEN KEIKI.

7-3. Disposal of products

When the detector is disposed of, it must be treated properly as an industrial waste in accordance with the local regulations.

8

Troubleshooting

The Troubleshooting does not explain the causes of all the malfunctions which occur on the detector. This simply helps to find the causes of malfunctions which frequently occur. If the detector shows a symptom which is not explained in this manual, or still has malfunctions even though remedial actions are taken, please contact RIKEN KEIKI.

<Abnormalities on Unit>

Symptom/Display	FAULT	Causes	Actions
<u>The power cannot be turned on.</u>	—	The wiring is not correct.	Connect the wiring properly.
		The terminal plate is removed.	Connect the terminal plate properly.
		Abnormalities/momentary blackout of power supply system	Provide the rated voltage. Take measures such as checking or adding the UPS, power supply line filter and insulation transformer.
		Cable abnormalities (open circuit/not connected/short circuit)	Check the wiring of detector and related devices around it.
<u>Abnormal operations</u>	—	Disturbances by sudden surge noise, etc.	Turn off and restart the alarm system. If such a symptom is observed frequently, take appropriate measures to eliminate the noise.
<u>System abnormalities</u> E-9	●	Abnormalities of ROM, RAM or EEPROM inside the detector	Please contact RIKEN KEIKI.
<u>Sensor abnormalities</u> E-1	●	The sensor is not connected or improperly connected.	Check if the sensor cable is securely fastened to the terminal plate.
		Faults of the sensor	Please contact RIKEN KEIKI.

<Abnormalities of Readings>

- * Take remedial actions to indicator/alarm unit as well See the operating manual of the indicator/alarm unit for details.

Symptoms	Causes	Actions
<u>The reading rises (drops) and does not go back.</u>	Drifting of sensor output	Perform zero adjustment.
	Presence of interference gas	It is difficult to eliminate interference gases, such as solvents completely. Please contact RIKEN KEIKI to arrange removal filters.
	Slow leak	A very small amount of the gas to be detected may be leaking (slow leak). Because ignoring it may cause dangers, take a remedial measure, i.e., taking actions the same as those for the gas alarm.
	Environmental changes	Perform zero adjustment.
<u>A gas alarm is triggered despite of no gas leak and no other abnormalities at the detection point.</u>	Presence of interference gas	It is difficult to eliminate interference gases, such as solvents completely. Please contact RIKEN KEIKI to arrange removal filters.
	Disturbance by noise	Turn off and restart the alarm system. If such a symptom is observed frequently, take appropriate measures to eliminate the noise.
	Sudden change in the environment	When the environment (temperature, etc.) changes suddenly, the detector cannot adjust to it and is affected by it. In some cases, the detector triggers an indication alarm. Because the detector cannot be used under sudden and frequent environmental changes, any preventive actions to eliminate them should be taken by the user.
<u>Slow response</u>	Deteriorated sensor sensitivity	Replace the sensor with a new one.
<u>Span adjustment impossible</u>	Improper calibration gas concentration	Use the proper calibration gas.
	Deteriorated sensor sensitivity	Replace the sensor with a new one.

9

Product Specifications

9-1. List of specifications

Detection principle	Electrochemical type
Gas to be detected	Toxic and combustible gases
Concentration display	7-segment LCD (4 digits)
Detection range	Depends on the gas to be detected
Detection method	Diffusion type
Transmission method	2-wire analog transmission
Transmission specifications	4 - 20 mA DC (load resistance: 300 Ω or less)
Power supply	15 - 27 VDC
Transmission cable	Shielded cable of CVVS, etc. (1.25 sq) - 2-core
Transmission distance	Up to 1 km with CVVS 1.25 sq (up to 600 m between the detector head and Zener Barrier)
Safety maintaining device ^{*1}	Zener Barrier (MTL728ac/MTL728+/MTL728-) or insulating barrier (MTL5541/RN-221N-EJ/KFD2-SCD-EX1.LK)
Operating temperature	0 - 40°C
Operating humidities	30 - 70%RH (Non-condensing.)
Structure	Box type/Wall mounted type
Explosion-proof structure	Intrinsically safe explosion-proof structure, with safety maintaining device (barrier) used
Explosion-proof class	ExialICT4
Explosion-proof certification number	TC20741
External dimensions	Approx. 100 (W) x 241 (H) x 48 (D) mm (projection portions excluded)
Weight	Approx. 1.0 kg
Outer color	Munsell 2.5Y9/2
Paint	Bake-coated with melamine

* Specifications subject to changes without notice.

*1 Recommended item

9-2. Detection principle

An electrochemical type sensor electrolyzes a gas directly while maintaining the interface between electrode and electrolyte at a constant potential (bias voltage). A gas is electrolyzed by an electrolysis cell to which a certain potential (bias voltage) is applied, and the gas is detected from the electrolytic current generated at that time.

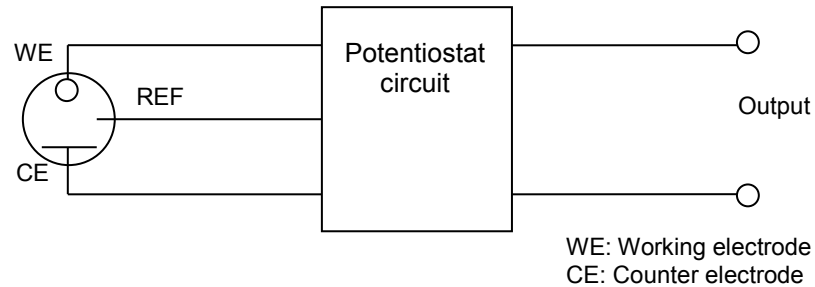

10

Definition of Terms

Electrochemical type	This is a principle of the sensor installed in the detector head. See "9-2. Detection principle" for details.
Initial clear	Output from the detector head fluctuates for a while after turning on the power. This is a function to prevent triggering alarm during that time.
Full scale	Maximum value of the detection range.
ppm	A concentration unit that means part per million of gas to be detected.
Calibration	Adjusts the readings to the calibration gas concentration value by using the calibration gas.